

SOLID OVERLAY UNITS

SOLID PANEL - READY DOOR (OP)



TUI-15-R-OP-D

TUI-15-L-OP-D

NOTE: Unit shown with overlay panel provided by others.

PLAN VIEW DIMENSIONS

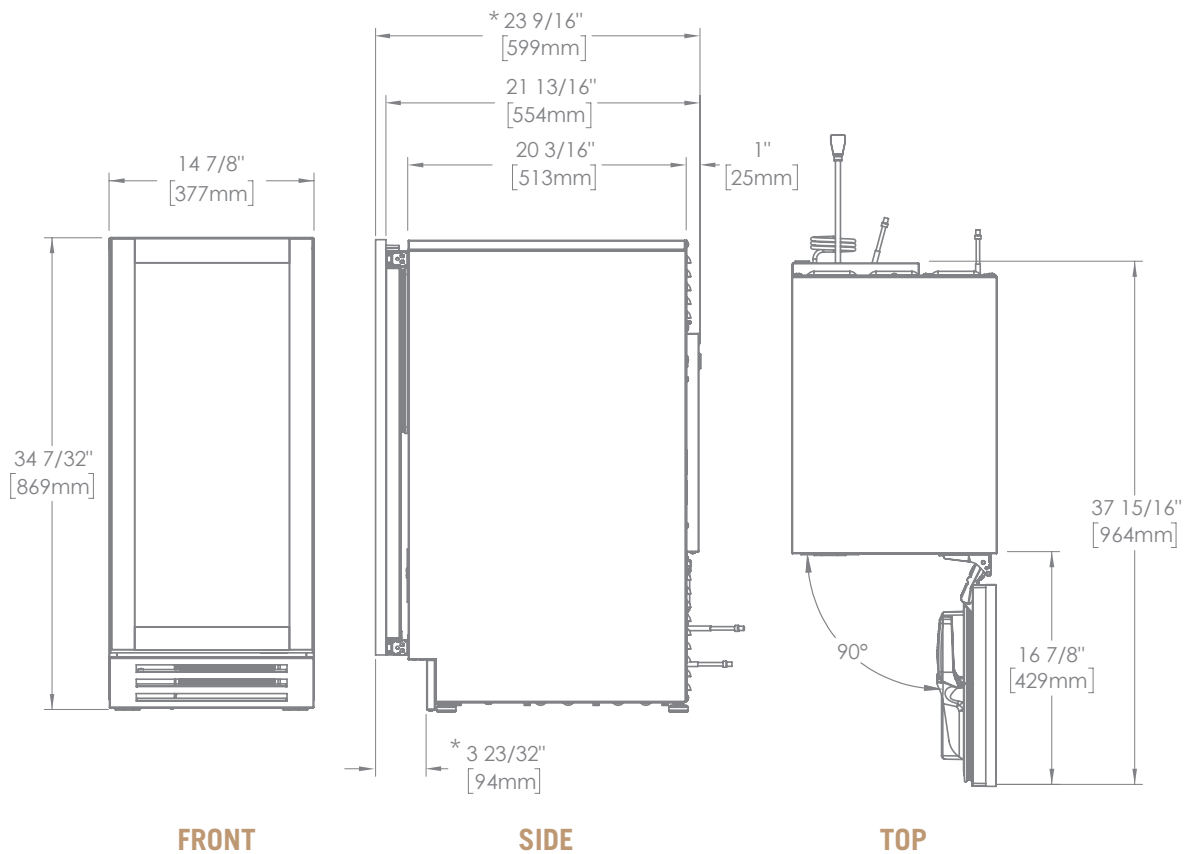

*Measures include 3/4" (19 mm) thick panel (not provided by True)
 Dimensions may vary by $\pm 1/8$ " (3.2 mm)

CUSTOM PANEL SPECIFICATIONS

Overlay units can be fitted with custom panels to match adjacent cabinetry. The integrated panel option extends above the door to conceal the hinge assembly to match full overlay cabinet doors.

See the picture below for reference. For installation instructions, please see “Custom Panel Installation”. (page 21).

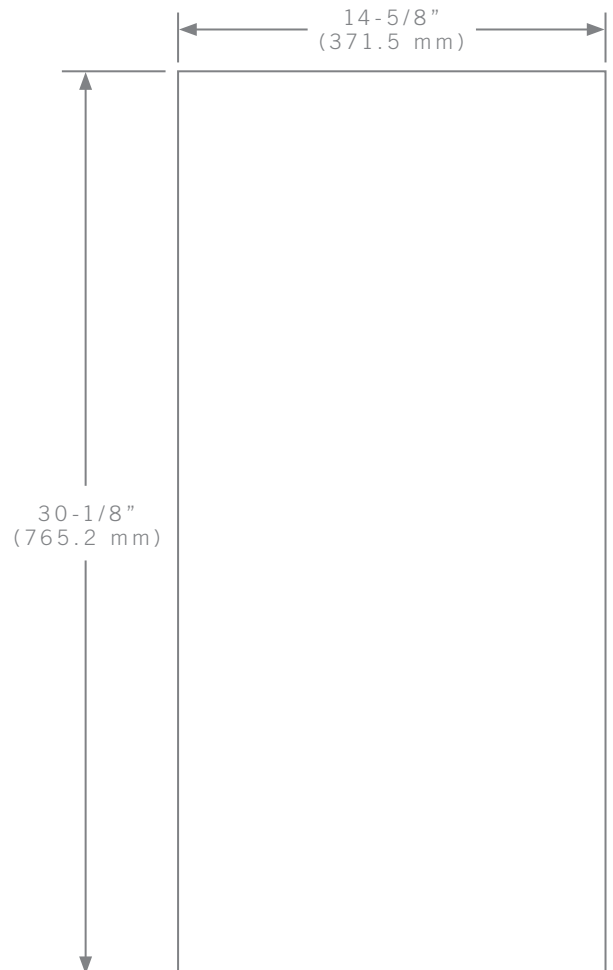

SPECIFICATIONS	
Panel Width	14-5/8" (371.5 mm)
Panel Height	30-1/8" (765.2 mm)
Panel Depth	3/4" (19 mm) max
Panel Weight	10 lb (4.5 kg) max
Rail Style Dimension	2" (50.8 mm) min

CUSTOM PANEL SPECIFICATIONS

If so desired, you can replace the kickplate with a custom overlay louver grill. Please see the template below.

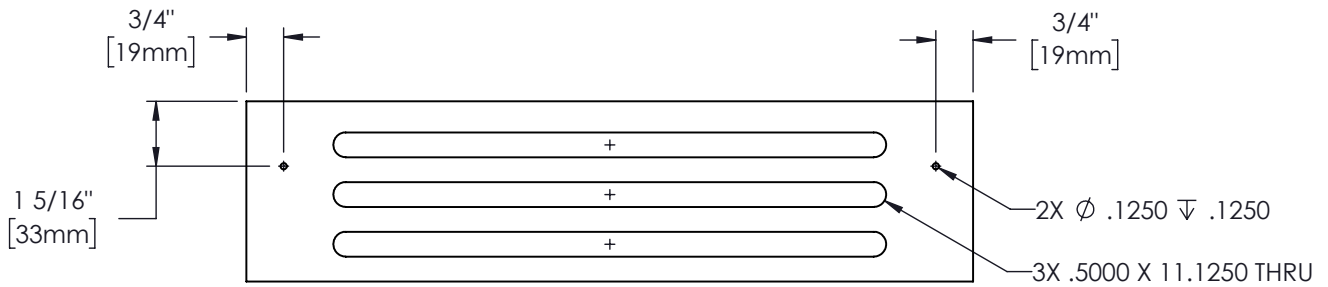
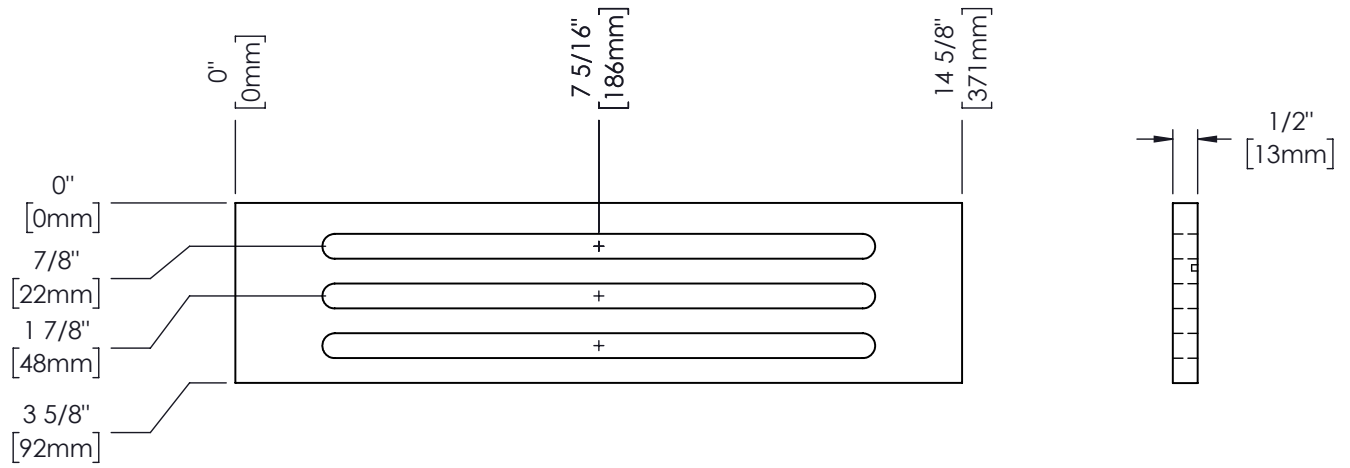

CUSTOM PANEL INSTALLATION

Your new ice machine comes with articulating, or soft-closing, hinges. The hinges can be installed on either the left or right to change the direction the door opens. Before installing panels, be sure the door assembly is oriented as desired. See “Reversing Door” (page 58). Please closely read all instructions before installing your panels.

REQUIRED TOOLS

Required tools include (but may not be limited to) the following.

- Surface protection*
- 2+ Clamps ≥ 2” (51 mm)
- 1/8” Hex Head Allen Wrench
- Phillips Screwdriver or Bit Driver
- 1/8” Drill Bit
- (Qty 6) #6 x 1/2” Screws**
- Drill

*Cardboard, moving blanket, foam padding, etc.

**Screw type varies by panel material.

INSTALLATION

1. Carefully lay the door overlay panel face down on a protected surface.

2. With a 1/8” hex head Allen wrench, loosen the cabinet hinge bolts. Then, remove the door. See fig. 1.

NOTE: DO NOT REMOVE THE HINGE FROM THE DOOR ASSEMBLY.

3. If NSF Cover is present, carefully pry screw caps from the cover to access the door bracket screws. See fig. 2.

NOTE: THE CAPS ARE INSTALLED WITH A TACKY GLUE THAT CAN BE EASILY REMOVED AND REINSTALLED.

4. Place the door front face down on the overlay panel. Then, align the bottom door bracket’s bottom edge with the overlay panel’s bottom edge. See figs. 3 and 4.
5. Clamp the door assembly panel.

NOTE: IF THE CLAMP JAWS ARE NOT PADDED, INSERT PADDING BETWEEN THE CLAMP AND THE OVERLAY TO PROTECT THE PANEL’S FINISH.
6. If desired, install a handle before proceeding to the next step. For best installation, fasten the handle with recessed screws.
7. With a 1/8” drill bit, carefully drill pilot holes into the door front. See fig. 5.

NOTE: TAKE CARE TO NOT DRILL THROUGH THE FRONT OF THE PANEL.
8. With the appropriate hardware, fasten the overlay panel to the door front. Then, remove the clamps.
9. Install the door assembly. Be sure to fully tighten the hinge screws.
10. Verify the door closes correctly and seals without gaps. Adjust the door as needed; see “Door Adjustment” (page 61).

PRIOR TO INSTALLATION



FIG. 1. Slide the door off the hinge bolts through the keyhole slots.

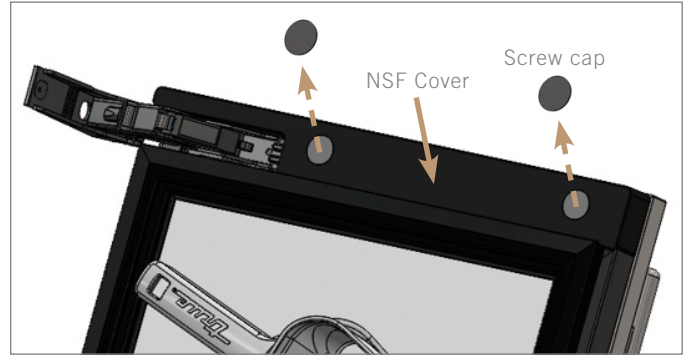

FIG. 2. Remove the NSF cover screw caps.

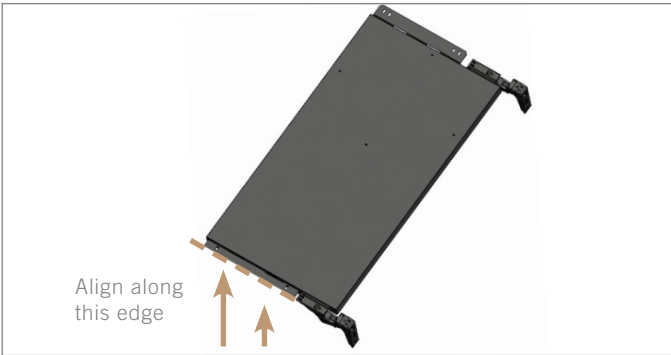

FIG. 3. Align along the bottom door bracket edge. Front of door assembly shown.

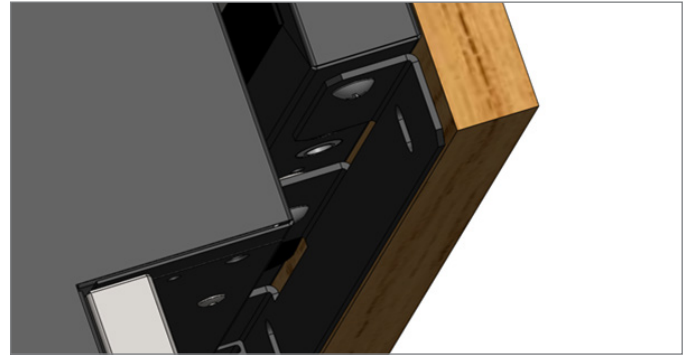

FIG. 4. The bottom edge of the panel should align with the bracket as shown.

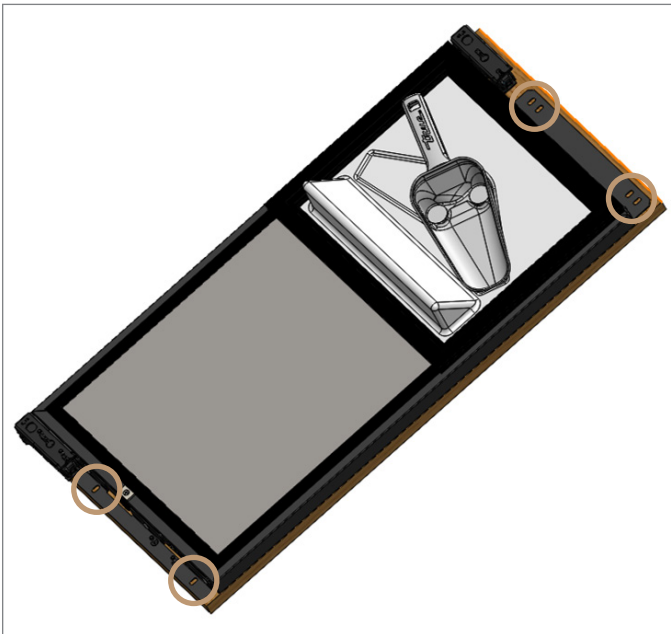

FIG. 5. Carefully fasten the overlay panel to the door front.